

CHERUBINI

tocco italiano dal 1947

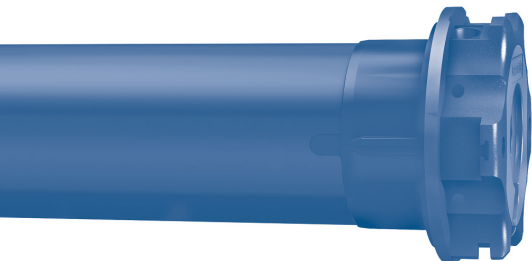

OPEN ZRX



MOTORE DOPPIA RADIO PER AVVOLGIBILI CON
FINECORSA ELETTRONICO

IT

DUAL RADIO MOTOR WITH ELECTRONIC LIMIT SWITCH
FOR ROLLING SHUTTERS

EN

DUAL-FUNKMOTOR FÜR ROLLLADEN MIT
ELEKTRONISCHER ENDLAGENEINSTELLUNG

DE

MOTEUR À DOUBLE COMMANDE RADIO POUR VOLET ROULANT
AVEC FINS DE COURSE ÉLECTRONIQUES

FR

MOTOR RADIO DUAL PARA PERSIANA CON
FIN DE CARRERA ELECTRÓNICO

ES



ISTRUZIONI - INSTRUCTIONS - EINSTELLANLEITUNGEN
INSTRUCTIONS - INSTRUCCIONES

Table of contents:

Motor installation: main steps	p. 36
How to prepare the motor	p. 37
Electrical connections	p. 38
Compatible remote controls	p. 39
Key to symbols	p. 40
Command sequences example	p. 41
Function open/close programming remote control	p. 42-43
Setting the first remote control	p. 44
Automatic disabling of the first remote control setting function	p. 44
Adjustment of the limit switches	p. 44
Setting in mode 1 (manual).....	p. 44
Example 1: Setting first the opening position	p. 45
Example 2: Setting first the closing position	p. 46
Mode 2: limit switch setting (semi-automatic)	p. 47
Setting a middle position	p. 48
Deleting the middle position.....	p. 48
Closing force adjustment	p. 49
Maximum closing force adjustment (100%)	p. 49
Deleting the opening and closing limit switch	p. 50
Setting of additional remote controls	p. 50
Remote control memory clearing	p. 50
Full memory clearing	p. 51
Special functions:	
Short-term setting of a remote control	p. 52
Setting the A530058 pocket remote control	p. 53
Electric wiring to motor command for UP-DOWN mode (2 independent up-down buttons)	p. 54
Command management from white wire UP-STOP-DOWN-STOP / UP-DOWN / UP-DOWN "dead man"	p. 55
Declaration of conformity	p. 162

Table of contents:

USING THE MOTOR INTO A Z-WAVE NETWORK	p. 56
Device description	p. 56
Z-WAVE technical specification	p. 56
Device installation.....	p. 57
Inclusion/exclusion the device into/from a Z-WAVE network (classic).....	p. 57
STANDARD inclusion (inclusion/exclusion).....	p. 58
SMARTSTART inclusion	p. 59
S2 SECURE inclusion	p. 59
Device control	p. 60
Controlling the motor by remote and external switches	p. 60
Controlling the motor with a Z-WAVE controller.....	p. 61
Reset to the factory settings	p. 62
Firmware update	p. 62
ADVANCED SETTINGS	
Supported command classes.....	p. 63
"COMMAND_CLASS_BASIC" support	p. 64
"COMMAND_CLASS_INDICATOR" support.....	p. 64
"COMMAND_CLASS_NOTIFICATION" support.....	p. 64
Associations	p. 65
Configurations	p. 66

MOTOR INSTALLATION: MAIN STEPS

- Installing the motor into the rolling shutter	p. 37
- Wired connections	p. 38
- Connecting the remote control	p. 44
- Setting the limit switches.....	p. 44
- Connecting to the Z-Wave system	from p. 56

HOW TO PREPARE THE MOTOR

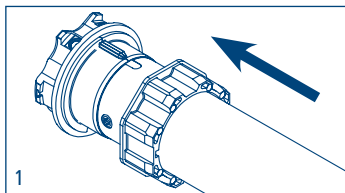
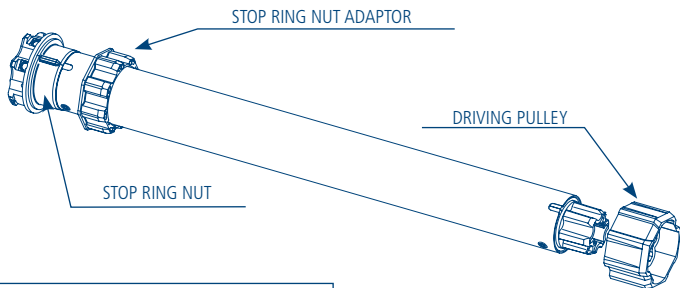

1. Insert the adaptor in the stop ring nut mating the groove with the reference notch and push till they touch.

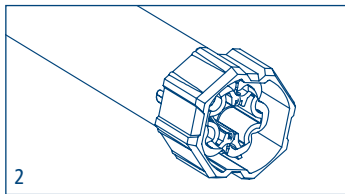

2. Fix the driving pulley on the motor pin until the stop pin clicks.

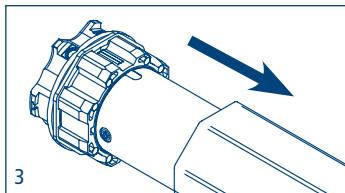

3. Insert the motor fully in the rolling tube.

NB: If you use tubes with a round form, the driving pulley must be fixed to the tube, and the installation is to be paid by the person who installs the system. For other tube sections the fitting is optional, but strongly recommended.

ELECTRICAL CONNECTIONS

- In order to prevent dangerous situations or malfunctioning, the electrical command elements wired to the motor must be sized according to the motor's electrical features.
- Means for disconnection must be incorporated in the fixed wiring in accordance with the national installation standards.
- For outdoor use, provide the appliance with a supply cable with designation H05RN-F containing at least 2% of carbon.
- If not used, the white wire must be insulated. It is dangerous to touch the white wire when the motor is powered.

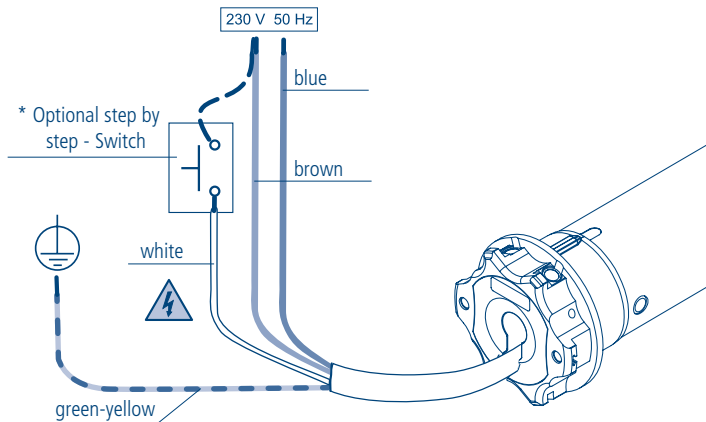

- * Installing this button is optional. The connection can be done differently using the brown wire or the blue wire. The button affords the possibility to command the motor in stepping mode (up, stop, down, stop, up, stop, down, stop..)

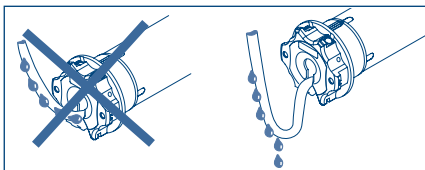

COMPATIBLE REMOTE CONTROLS

GIRO

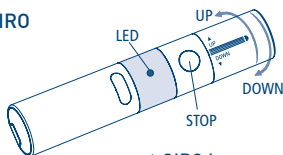

GIRO Wall

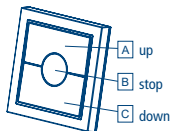

GIRO Plus

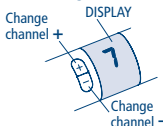

GIRO Lux

Activating the Sun sensor

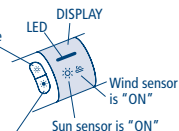

Deactivating the Sun sensor

GIRO P-Lux

Change channel

DISPLAY

7



Activating/ Deactivating the Sun sensor

POP

POP Lux

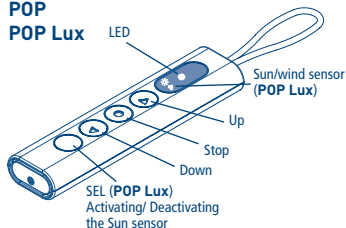

POP Plus

POP P-Lux

Sun/wind sensor (POP P-Lux)

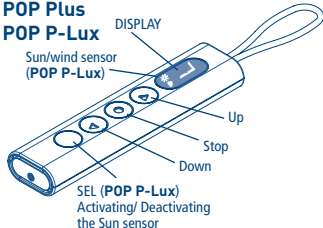

SKIPPER
SKIPPER Lux
SKIPPER Plus
SKIPPER P-Lux

LED - SKIPPER

display -
SKIPPER Lux
SKIPPER Plus
SKIPPER P-Lux

Channel selector

Activating/ Deactivating the Sun sensor
SKIPPER Lux
SKIPPER P-Lux

SKIPPER LCD
SKIPPER SENSO

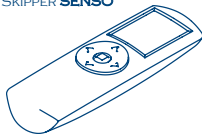

Check the specific instruction book

A530058 Remote Control with 4 independent channels



KEY TO SYMBOLS

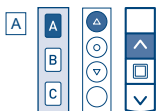
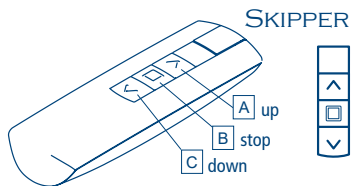
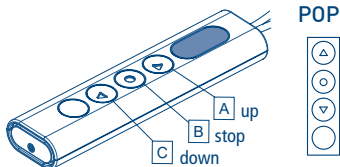
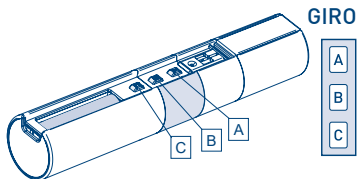
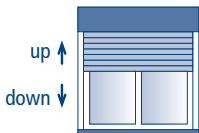

Press button A

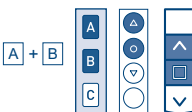

Press buttons A and B
at the same time



Press the
bottom
UP



Press the
bottom
DOWN



Release



short motor rotation
in one direction



long motor rotation
in other direction



double short
rotation

COMMAND SEQUENCES EXAMPLE

Most of the command sequences have three distinct steps, at the end of which the motor indicates if the step has been concluded positively or not, by turning in different ways. This section is provided to demonstrate the motor indications. The buttons must be pressed as shown in the sequence, without taking more than 4 seconds between one step and the next. If more than 4 seconds are taken, the command is not accepted and the sequence must be repeated.

Command sequence example:

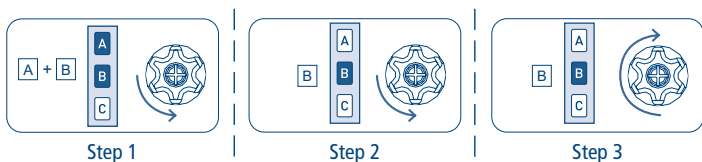

As we can see from the example, when the sequence ends positively, the motor returns to its starting position in one long rotation. In fact, two short rotations in the same direction correspond to one long rotation in the opposite direction. The motor returns to the starting position even when the sequence is not completed; in this case by performing one or two short rotations.

Example of a wrong sequence:

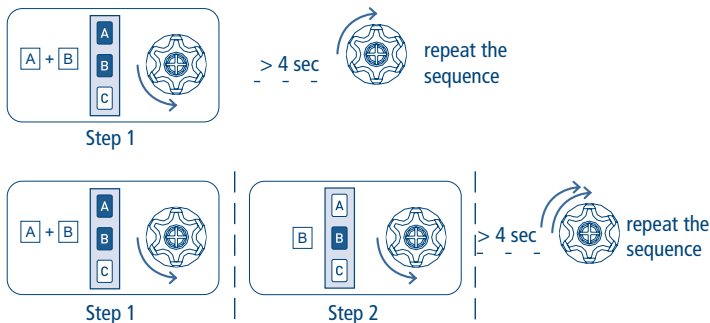

FUNCTION OPEN/CLOSE PROGRAMMING

REMOTE CONTROL SKIPPER PLUS - SKIPPER LUX - SKIPPER P-LUX

REMOTE CONTROL POP PLUS - POP LUX - POP P-LUX

To prevent accidental changes to the programming of the motor during the daily use of the remote control, the possibility of programming is disabled automatically 8 hours after sending the last sequence (A+B or B+C).

CHECKING THE STATUS OF THE FUNCTION

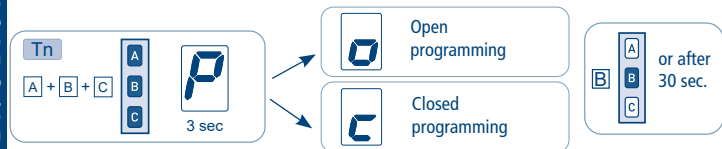

To change the status of the function, see the sequences "ENABLE/DISABLE PROGRAMMING".

ENABLE PROGRAMMING

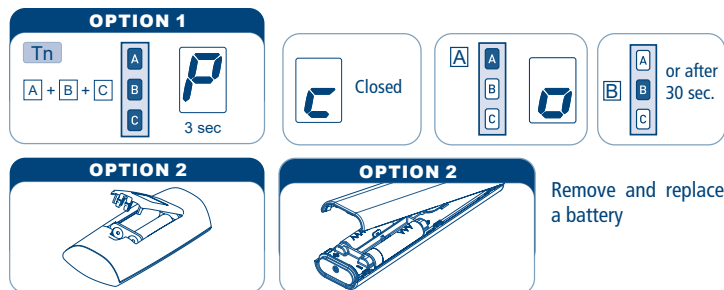

Remove and replace a battery

Proceed with programming as the instructions booklet.

DISABLE PROGRAMMING



FUNCTION OPEN/CLOSE PROGRAMMING

REMOTE CONTROL SKIPPER - SERIES GIRO - REMOTE CONTROL POP

To prevent accidental changes to the programming of the motor during the daily use of the remote control, the possibility of programming is disabled automatically 8 hours after sending the last sequence (A+B or B+C).

CHECKING THE STATUS OF THE FUNCTION

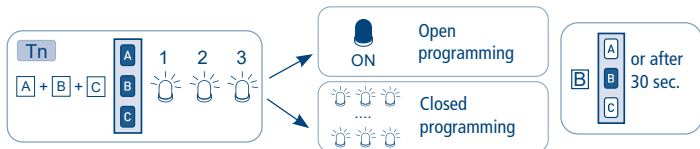

To change the status of the function, see the sequences "ENABLE/DISABLE PROGRAMMING".

ENABLE PROGRAMMING

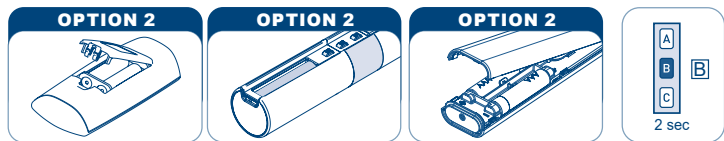
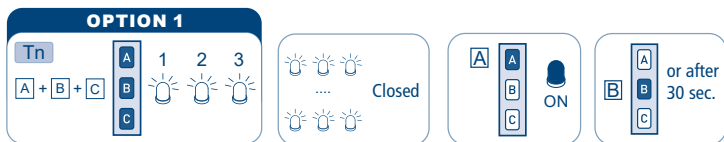

Remove one battery and wait minimum 5 seconds or press any button.

Proceed with programming as the instructions booklet.

DISABLE PROGRAMMING



SETTING THE FIRST REMOTE CONTROL

This operation can only be performed when the motor is new, or after a total delete of the memory.

During this step, power up only one motor at time!

T1: First remote control to be set

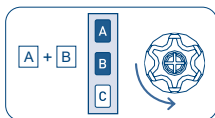

T1

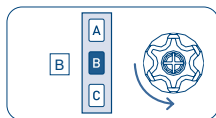

T1

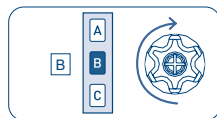

T1 (2 sec)

AUTOMATIC DISABLING OF THE FIRST REMOTE CONTROL SETTING FUNCTION

Every time you connect the power supply to the motor, you have 3 hours to store the first remote control. After this time, the ability to store the remote control is disabled. To reset the timer of the function you have to disconnect and reconnect the power supply to the motor.

ADJUSTMENT OF THE LIMIT SWITCHES

OPEN ZRX tubular motor have an electronic limit switch system with an encoder. This system ensures great reliability and precision in keeping the positions. Limit switch regulation is performed simply with the remote control. During setting, the motor moves only as long as the up or down button is pressed, stopping when the button is released. At the end of setting, press either the up or down button briefly to move the motor. The adjustments of the limit switches can be done in different modes depending on whether the rolling shutter is equipped with lockdown hangers or physical stops.

SETTING IN MODE 1 (manual)

In this mode it doesn't matter whether or not the rolling shutter has got physical stops in the opening position and the lockdown hangers in the closing position. It is possible to choose whether to set the upper limit or the lower limit first. The correct rotation direction will only be identified after the first position is set so it is sometimes necessary to use the "up" or "down" button.

EXAMPLE 1: Setting first the opening position

SETTING THE OPENING POSITION

If the rolling shutter is completely open, you have first to drive it down by around 20 cm.

Hold the button A or C pressed and drive the rolling shutter to the opening position.

With physical stops: press button A or C until the motor stops automatically.

Without physical stops: use the button A or C to drive the rolling shutter to the necessary opening position.

To set the opening position, press buttons A (up) and B (stop) simultaneously for about 2 seconds, until the motor automatically performs a short "down" movement.

This move is the visual confirmation of the setting operation.

Tn: Already programmed remote control

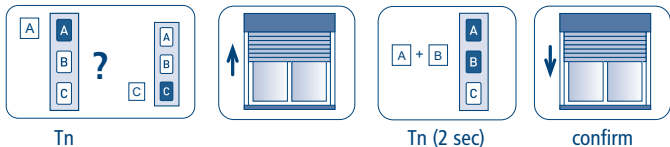

SETTING THE CLOSING POSITION

Pressing now the button C, drive completely down the rolling shutter to the closing position.

With lockdown hangers: press button C until the motor stops automatically.

Without lockdown hangers: use the button A or C to drive the rolling shutter to the necessary closing position.

To set the closing position, press buttons B (stop) and C (down) simultaneously for about 2 seconds, until the motor automatically performs a short "up" movement.

This move is the visual confirmation of the setting operation.

Tn: Already programmed remote control

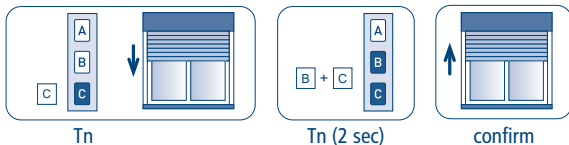

EXAMPLE 2: Setting first the closing position

SETTING THE CLOSING POSITION

If the rolling shutter is completely closed, you have first to drive it up by around 20 cm.

Hold the button A or C pressed and drive the rolling shutter to the closing position.

With lockdown hangers: press buttons A or C until the motor stops automatically.

Without lockdown hangers: use the button A or C to drive the rolling shutter to the necessary closing position.

To set the closing position, press buttons B (stop) and C (down) simultaneously for about 2 seconds, until the motor performs automatically a short "up" movement.

This move is the visual confirmation of the setting operation.

Tn: Already programmed remote control

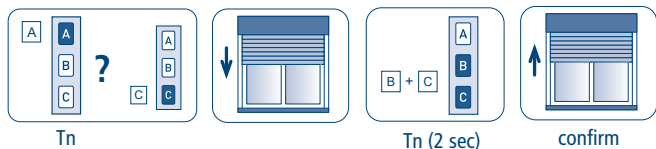

SETTING THE OPENING POSITION

Pressing now button A, drive completely up the rolling shutter to the opening position.

With physical stops: press button A until the motor stops automatically.

Without physical stops: use the button A or C to drive the rolling shutter to the necessary opening position.

To set the opening position, press buttons A (up) and B (stop) simultaneously for about 2 seconds, until the motor automatically performs a short "down" movement.

This move is the visual confirmation of the setting operation.

Tn: Already programmed remote control

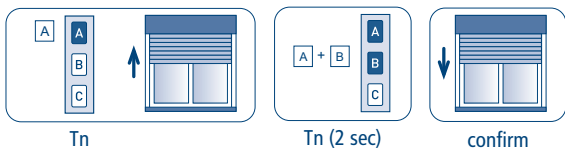

MODE 2: LIMIT SWITCH SETTING (semi-automatic)

To do the settings in this mode the rolling shutter has to be equipped with lockdown hangers in the closing position, but the rolling shutter does not need to have physical stops in the opening position. This mode of setting is helpful in cases where the factory will set the opening position and the closing position will be set automatically during the normal use.

In this mode, it's necessary to set first the opening position!! (Rolling shutter open!)

SETTING THE OPENING POSITION

If the shutter is already completely open, you have first to drive it down by about 20 cm.

Press button A or C and drive the rolling shutter to the opening position.

With physical stops: press button A or C until the motor stops automatically.

Without physical stops: use buttons A and C to drive the rolling shutter to the necessary opening position.

To set the opening position, press button B (stop) for about 2 seconds, until the motor performs a short downwards movement. After this confirmation movement the motor brings back the rolling shutter to the opening position.

Tn: Already programmed remote control

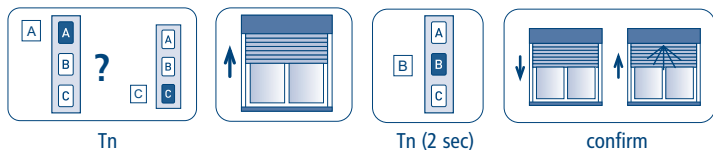

Now the drive direction is detected and the motor can be disconnected from the power. The closing position will be set automatically during the normal use. When the motor is powered up again, the remote control can be used normally. The lower limit switch position will be set automatically the first time the rolling shutter stops automatically in the closing position using the lock down hangers. As the motor looks for a "mechanical" stop during each way down, if the Obstacle Recognition finds something is blocking the way (such as a protruding screw in the guide rails), it is necessary to raise the shutter again, remove the obstacle and to drive the motor back to the closing position to set the limit.

SETTING A MIDDLE POSITION

This function allows the rolling shutter to be set at a favourite middle position. When this middle position is memorized, you just press the stop button for 2 seconds and automatically the motor will move the shutter to this position.

To memorize the middle position, move the rolling shutter to the desired position and then hold the STOP button down (for about 2 sec) until the motor gives confirmation.

Tn: Already programmed remote control



Tn (4 sec)

MOVEMENT TO MIDDLE POSITION

It's possible to control the motor in the middle position in two ways:

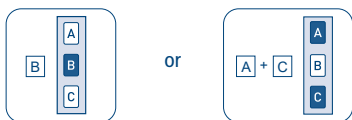

Tn (2 sec)

DELETING THE MIDDLE POSITION

If you want to delete the middle position, it can be done as described below.

To change this position, it's also necessary to delete first the memorized middle position. Before deleting it's necessary to drive the motor to the middle position (by pressing button B for 2 seconds), then press again button B (stop) for about 4 seconds until the motor confirms the operation by a longer movement.

Tn: Already programmed remote control

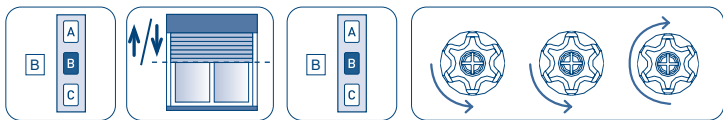

Tn (2 sec)

Tn (4 sec)

CLOSING FORCE ADJUSTMENT

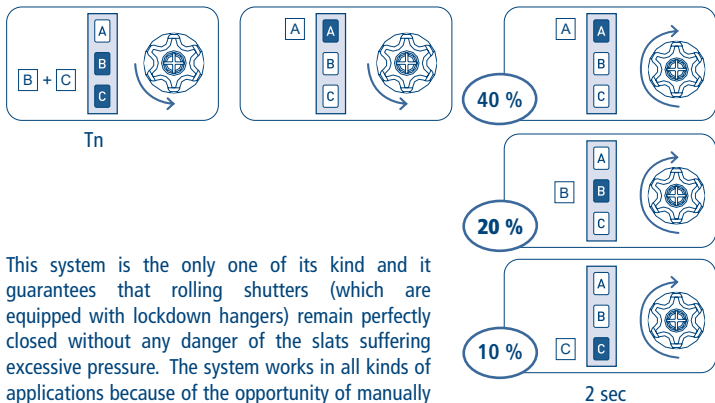

This system is the only one of its kind and it guarantees that rolling shutters (which are equipped with lockdown hangers) remain perfectly closed without any danger of the slats suffering excessive pressure. The system works in all kinds of applications because of the opportunity of manually adjusting the closing force.

The OPEN ZRX is factory set to a closing force of 20 % of the nominal torque. This force can be changed very easily by the remote control. It can be reduced by 10 % or increased up to 40 %, depending on the desired result.

MAXIMUM CLOSING FORCE ADJUSTMENT (100%)

A close attention on activating this function is recommended, excessive closing force may damage the rolling shutters.

By activating this function the motor will apply its maximum nominal torque, (e.g. 100% of 50 Nm = 50 Nm).

T_n : Already programmed remote control

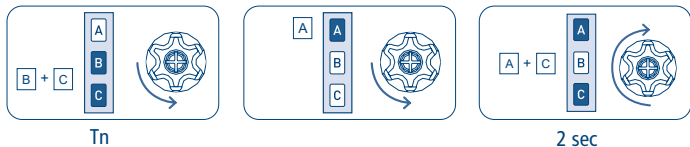

DELETING THE OPENING AND CLOSING LIMIT SWITCH

Tn: Already programmed remote control

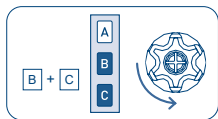

Tn

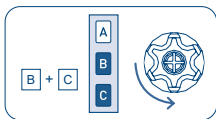

Tn

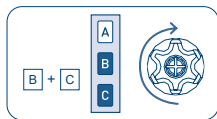

Tn (4 sec)

NB: by deleting the limit switches, the setting of the closing force is maintained.

SETTING OF ADDITIONAL REMOTE CONTROLS

Up to 15 remote controls can be set.

Tn: Already programmed remote control

Tx: Additional remote control

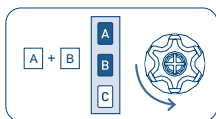

Tn

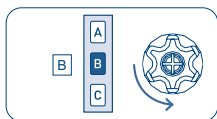

Tn

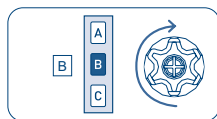

Tx (2 sec)

REMOTE CONTROL MEMORY CLEARING

It is possible to delete singly all the memorized remote controls. When the last one is deleted the motor initial condition is restored. The same applies to the single channels of a multichannel remote control: just select the channel to cancel before performing the sequence.

Tn: Remote control to be cleared

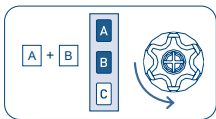

Tn

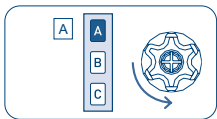

Tn

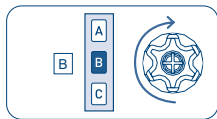

Tn (2 sec)

FULL MEMORY CLEARING

This full memory clearing does not delete the setting of the limit switch.

The full memory clearing can be performed in two ways:

1) WITH THE REMOTE CONTROL

Tn: Already programmed remote control

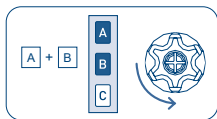

Tn

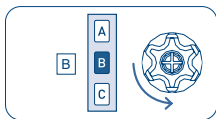

Tn

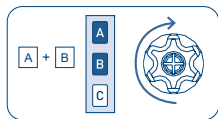

Tn (4 sec)

2) WITH THE WHITE WIRE

Do this operation only in case of emergency, if all remote controls are no longer operating. To delete the memory we have to access the white wire of the motor.

The sequence of this operation is the following:

- 1) Disconnect the power supply from the motor, via the main switch for example.
- 2) Connect the white motor wire to the brown wire (phase) or to the blue wire (neutral).
- 3) Connect the power supply to the motor, which rotates briefly in one direction.
- 4) Disconnect the power supply from the motor for at least 4 seconds.
- 5) Connect the power supply to the motor which performs one brief rotation in one direction after around 4 seconds and then a longer one in the opposite direction.
- 6) Disconnect the power supply from the motor.
- 7) Separate the white wire from the brown/blue wire. Insulate the white wire, in an appropriate way, before reconnecting the power supply.

At this point it is possible to proceed with the setting of the first remote control.

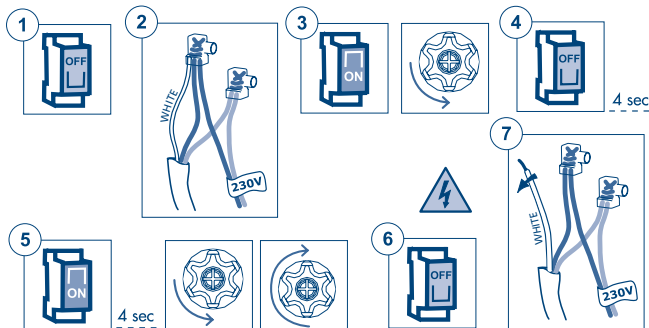

SPECIAL FUNCTIONS

SHORT-TERM SETTING OF A REMOTE CONTROL

This function makes it possible to store a remote control temporarily, for example, with the purpose of setting the limit switches during assembly in the factory. A later final saving of the remote control will be possible using the appropriate command sequence (see: "SETTING THE FIRST REMOTE CONTROL"). The operations described below can be carried out only when the motor has just come out of the factory or after a full memory clearing (see: "FULL MEMORY CLEARING"). The motor makes the following operations possible only within the time limits described in order to make sure that the short-term setting is used only in the installation or factory setting phase and not during daily use. Power up the motor, make sure that no other motors having an empty memory are powered up in the same operating range.

Within 30 seconds after start, press the B and C buttons simultaneously until the motor gives a confirmation signal.

The remote control will remain stored for 5 minutes, while the motor is powered up. After 5 minutes or when the motor has its power cut off, the remote control will be cancelled.

T1: First remote control to be set

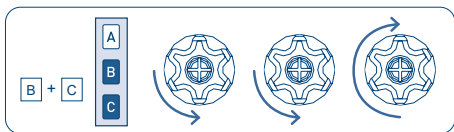

T1

SETTING THE A530058 POCKET REMOTE CONTROL

NB: The new pocket remote control can be set only after programming of a previous remote control as the traditional Cherubini remote controls (Skipper, Giro or POP - 3 buttons Up-Down-Stop remote control).

HOW TO PROCEED TO SET THE BUTTON ON THE POCKET REMOTE CONTROL

Tn: Already programmed remote control

Tx: Pocket remote control to be set

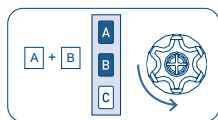

Tn

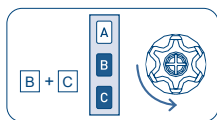

Tn

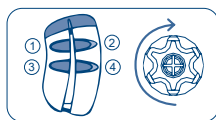

Tx (2 sec)

After to have pressed for minimal 2 seconds one of the 4 buttons on the pocket remote control, this one will be memorized on the step-by-step mode (UP-STOP-DOWN-STOP). The following buttons will be not memorized and have to be done with previous described sequence, and could be used to move additional OPEN ZRX motors.

DELETING ONE BUTTON ON THE POCKET REMOTE CONTROL

The buttons saved may be deleted individually according to the following sequence:

Tn: Already programmed remote control

Tx: Pocket remote control with button to be deleted

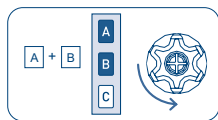

Tn

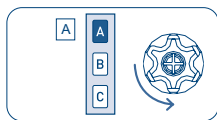

Tn

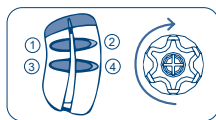

Tx (2 sec)

To confirm the operation the motor will do a short shunt and the button, which has to be pressed for minimal 2 second, will be deleted.

ELECTRIC WIRING TO MOTOR COMMAND FOR UP-DOWN MODE (2 independent UP-DOWN buttons)

To connect the switch, use only kind of switches with mechanical or electrical interlock, to prevent to press both buttons at same time.

The motor automatically recognizes the switch-type (with 1 or 2 buttons) and sets the proper operational mode.

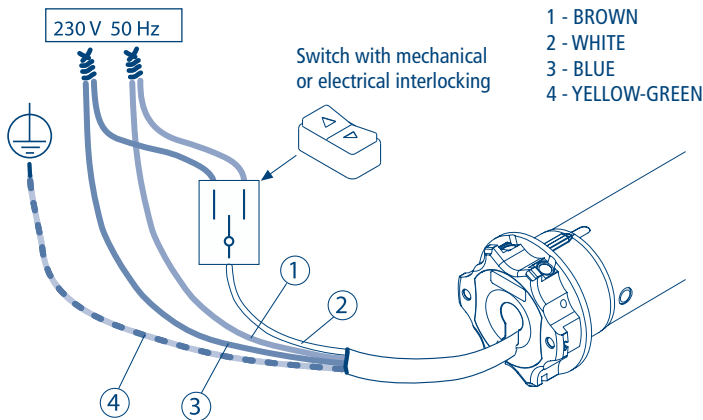

From white wire it's possible to control the motor in the middle position:

press UP long (> 2 s):



or use the short UP sequence (< 0,5 s) - short DOWN (< 0,5 s)



Using the switch as described on this page it's possible to set the motor trough the white wire (WIRE PROGRAMMING).

To find out this procedure, require the instruction pamphlet from your dealer.

COMMAND MANAGEMENT FROM WHITE WIRE

UP-STOP-DOWN-STOP / UP-DOWN / UP-DOWN "DEAD MAN"

NB: The default function provided in the motors leaving the factory is UP-STOP-DOWN-STOP for singular UP/DOWN button switch. (Not for the switch with two independent UP-DOWN buttons!)

PROCEDURE TO CHANGE THE CONTROL MODE:

Tn: Already programmed remote control

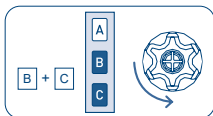

Tn

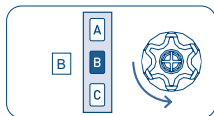

Tn

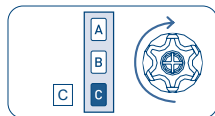

Tn (2 sec)

The possible settings are 3 and are available in the following order:

- UP-STOP-DOWN-STOP (factory setting)
- UP-DOWN (for 2 independent buttons)
- UP-DOWN "DEAD MAN" (for 2 independent buttons)

To switch from one setting to the following, perform the sequence as many times as necessary to reach the desired setting.

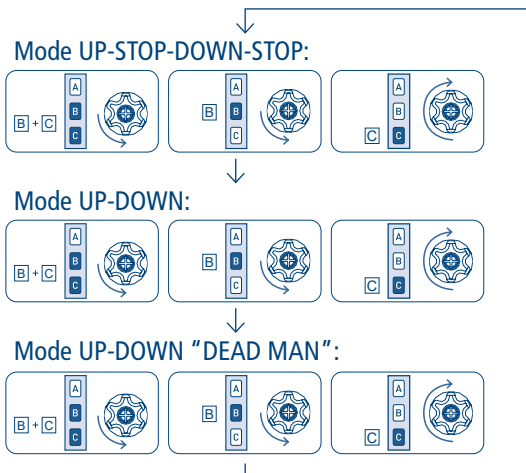

USING THE MOTOR INTO A Z-WAVE NETWORK

DEVICE DESCRIPTION

OPEN ZRX is a rolling shutters motor with programmable limit switches, dual-radio control and wired control option.

The dual-radio control allows, on the one hand, the adjustment of the limit switches and the main functions to be carried out simply and interactively and, on the other hand, to be integrated into a Z-Wave network.

The wired control option provides for both programming and motor control, from a simple switch, as an addition or as an alternative to the radio remote control. This product operates in any Z-Wave network with other Z-Wave/Z-Wave Plus certified devices and controllers from any other manufacturer. As a constantly powered node, ORA ZRX will act as repeater regardless of the vendor in order to increase the reliability of the network.

Z-WAVE TECHNICAL SPECIFICATION

Power supply	230 VAC \pm 10% 50 Hz
Operating temperature	From -10° to 40° C
Power consumption in stand-by	< 1W
Radio frequency	868,4 MHz
Protection system	S2 Security
Maximum range	up to 100 m outdoor up to 40 m indoor
Compliance	CE, RoHs
Electrical IP Rating	IP44

INSTALLAZIONE DEL DISPOSITIVO

- 1) Carry out motor preparation and installation on the rolling shutter
- 2) Wire up the electrical connections
- 3) Program the limit switches and the adjustments as described in the product installation manual.
- 4) Include the device in the Z-Wave network

It is advisable to carry out all the preparation, installation and adjustment operations before including the motor in the Z-Wave network. Although it is possible to include the motor in a Z-Wave network, most features will not be active until the limit switches are adjusted. In particular, the following are not active:

- Movements control and position reporting
- Notifications sending
- Movements requested by "COMMAND_CLASS_INDICATOR" class

These limitations are necessary to limit the possibility of damage to the rolling shutter, as well as to protect the safety of the installer.

INCLUSION/EXCLUSION THE DEVICE INTO/FROM A Z-WAVE NETWORK (classic)

OPEN ZRX is compatible with all Z-Wave/Z-Wave Plus certified controllers. The devices support both the **Network Wide Inclusion** (which offers the ability to be included in a network, even if the device is not directly connected to the controller) and **Standard Inclusion**.

By default setting, the inclusion procedure starts in **Standard Inclusion** mode and after a short timeout the procedure continues in **Network Wide Inclusion** mode that lasts for about 20 Seconds.

STANDARD INCLUSION (INCLUSION/EXCLUSION)

Make sure that the motor is powered and possibly connected to an up/down button if you wish to use the wired programming sequence, or have a remote control already saved in the motor. Before starting the inclusion process, make sure that the motor is not already included in a Z-Wave network; if it is already included, perform the procedure described below: first time to exclude the motor, second time to include it into the proper Z-Wave network.

The sequence of operations for inclusion/exclusion procedure is as follows:

- 1) Prepare the Z-Wave controller for inclusion (or exclusion) of a device (see your controller's instructions).
- 2) On the motor, run the programming sequence for inclusion/exclusion:
 - a. By the remote control: AB - AC - AB (2 seconds), wait for confirmation movements.

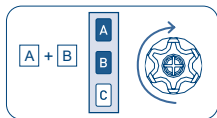
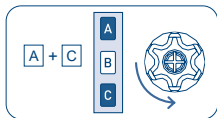
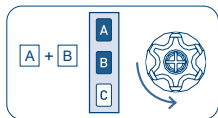

2 sec

- b. By the button (if the end stops are not adjusted, you can use either sequence indifferently):

- i. With the motor on the high limit switch: UP-UP-UP-UP-UP-DOWN

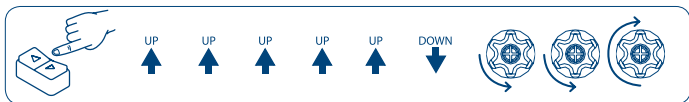

- ii. With the motor on the low limit switch: DOWN-DOWN-DOWN-DOWN-DOWN-UP

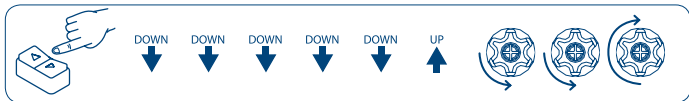

- 3) The motor performs a few short movements to signal that the inclusion (or exclusion) procedure is in progress.
- 4) Check the controller to verify that the procedure was successful.

SMARTSTART INCLUSION

Z-Wave SmartStart aims to shift the tasks related to inclusion of an end device into a Z-Wave network away from the end device itself, and towards the more user-friendly interface of the gateway.

Z-Wave SmartStart removes the need for initiating the end device to start inclusion. Inclusion is initiated automatically on power-ON, and repeated at dynamic intervals for as long as the device is not included into a Z-Wave network. As the new device announces itself on power-ON, the protocol provides notifications, and the gateway can initiate the inclusion process in the background, without the need for user interaction or any interruption of normal operation. The SmartStart inclusion process only includes authenticated devices.

OPEN ZRX can be added to a Z-Wave network by scanning the Z-Wave QR Code attached to the product with a controller providing SmartStart inclusion. No further action is required and the SmartStart product is added automatically within 10 minutes after being switched on inside the network range.

The QR code and the DSK are shown in numerical format on the label attached to the motor cable. The PIN is the first group of 5 digits printed underlined. To facilitate consultation of these codes, the label has a detachable, self-adhesive part, which can be kept in the instruction manual, or applied in an easily accessible place on the roller shutter (box or final slat).

S2 SECURE INCLUSION

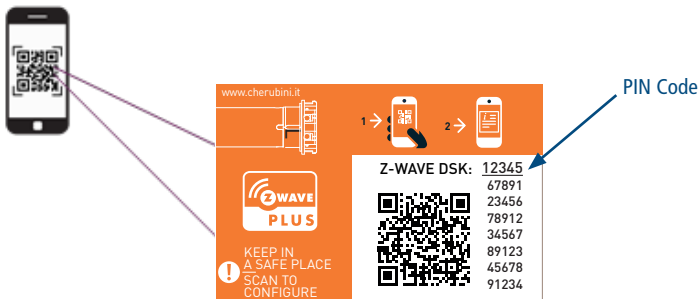

The PIN code of the Z-Wave Device Specific Key (DSK) is required when adding the OPEN ZRX to a Z-Wave network with a controller supporting Security 2 Authenticated (S2). The unique DSK code is printed on the product label. The first five digits of the key are highlighted and underlined to help the user identify the PIN code portion of the DSK text.

DEVICE CONTROL

CONTROLLING THE MOTOR BY REMOTE AND EXTERNAL SWITCHES

OPEN ZRX can be controlled by radio remote control and by wired button.

When installing the motor on the rolling shutter, the radio remote control is extremely useful to set the limit switches and perform all programming. After the first installation, the remote control can still be used as a local control point. All information regarding compatible devices and programming methods are described in the product installation manual.

From the remote control, you can execute the basic commands:

- Closing the rolling shutter: press and release the UP button
- Opening the rolling shutter: press and release the DOWN button
- Stop the rolling shutter: press and release the STOP button.

OPEN ZRX can also be controlled by a wired button, both single and a double-action (up/down).

With the single action button, the operation is as follows:

- Each time the button is pressed/released, the motor will perform the following operations in sequence: Closing, Stopping, Opening, Stopping and so on.

With the double-action button:

- Closing the rolling shutter: press and release the DOWN button
- Opening the rolling shutter: press and release the UP button
- Stop the rolling shutter: press and release the UP or DOWN button while the motor is moving.

Factory default setting:

- No remote control is associated with the motor. The motor can be controlled via a wired button, but until the limit switches are set, it moves in 'dead man' mode: when the button is released, the motor stops.
- As long as the limit switches are not set, the direction of movement of the motor may be reversed, compared to the remote control and the wired double-action button. The direction is correctly identified automatically by the motor itself when the limit switches are set and cannot be changed.

Further information about the operation of the remote control and the wired button can be found in the product installation manual.

CONTROLLING THE MOTOR WITH A Z-WAVE CONTROLLER

OPEN ZRX can be controlled by any Z-Wave / Z-Wave Plus certified controller available in the market. In the figure below it's shown how the device will appear once included into the METAHome Controller.

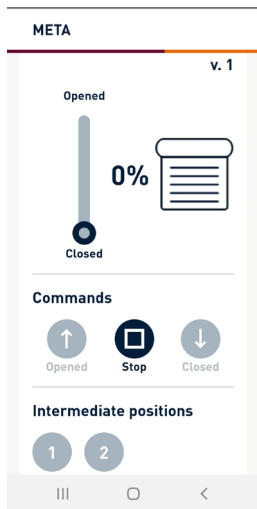

The UP/DOWN/STOP buttons in the control panel allow to Open/Close/Stop the rolling shutter. Using the slider it is possible to set the opening level of the rolling shutter. The device status is updated in case of status change.

RESET TO THE FACTORY SETTINGS

The Z-Wave configuration of the ORA ZRX motor can be reset to the original factory values with the following programming sequence:

- 1) From the remote control: AB - AC - BC (4 seconds), wait for confirmation movements to be executed.

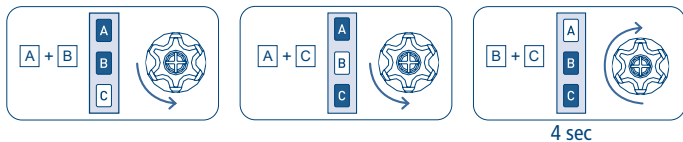

- 2) From the button (if the end stops are not adjusted, you can use either sequence indifferently):

- a. With the motor on the high limit switch: UP-UP-UP-DOWN-UP-DOWN

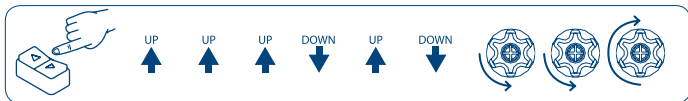

- b. With the motor on the low limit switch: DOWN-DOWN-DOWN-UP-DOWN-UP

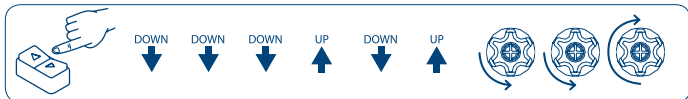

i **INFO:** If the reset is performed while the device is still part of a network, it notifies the other devices in the lifeline group that it has been removed (Device Reset Locally Notification).

FIRMWARE UPDATE

The system supports over-the-air firmware updates that do not require the device to be removed from its location. The firmware update can be activated from all certified controllers supporting version 2 of the Firmware Update function.

! **WARNING:** The system will be rebooted at the end of the firmware update procedure. It is advisable to carry out the firmware update procedure only when necessary and following careful planning of the intervention.

ADVANCED SETTINGS

SUPPORTED COMMAND CLASSES

Command Class	Version	Non-Secure CC	Secure CC
COMMAND_CLASS_ZWAVEPLUS_INFO	2	x	
COMMAND_CLASS_APPLICATION_STATUS	1	x	
COMMAD_CLASS_INDICATOR	2		x
COMMAND_CLASS_ASSOCIATION	2		x
COMMAND_CLASS_MULTI_CHANNEL_ASSOCIATION	3		x
COMMAND_CLASS_ASSOCIATION_GRP_INFO	2		x
COMMAND_CLASS_TRANSPORT_SERVICE	1	x	
COMMAND_CLASS_VERSION	2		x
COMMAND_CLASS_MANUFACTURER_SPECIFIC	2		x
COMMAND_CLASS_POWERLEVEL	1		x
COMMAND_CLASS_CONFIGURATION	4		x
COMMAND_CLASS_SECURITY_2	1	x	
COMMAND_CLASS_SUPERVISION	1	x	
COMMAND_CLASS_FIRMWARE_UPDATE_MD	5		x
COMMAND_CLASS_BASIC	2		x
COMMAND_CLASS_WINDOW_COVERING	1		x
COMMAND_CLASS_MULTILEVEL	4		x
COMMAND_CLASS_NOTIFICATION	8		x

“COMMAND_CLASS_BASIC” SUPPORT

The device supports Indicator V3 with Indicator ID 0x50 (identity).

“COMMAND_CLASS_INDICATOR” SUPPORT

The device supports Indicator V3 with Indicator ID 0x50 (identity).

When the device receives an indicator set, the motor will perform opening and closing movements of the rolling shutter. The number of movements will be a maximum of 15, with a minimum stroke time of 0.5 s, and a minimum pause time of 0.5 s.

Note: to prevent damage to the slats and the structure of the rolling shutter, movements are only performed if the end switches have been saved.

“COMMAND_CLASS_NOTIFICATION” SUPPORT

The device is able to send a system notification in the event of an obstacle.

Notification Event Code	The meaning associate to the event
3 (System Error Failure)	This notification is sent when the motor reach an obstacle during its operation. The parameter event associate to this event is 1 Byte with the following meaning: 1) collision during opening 0) collision during closing

ASSOCIATIONS

The device supports 4 association groups, each of which supports the association of up to 5 devices (nodes):

ID del gruppo	Nome del gruppo	N° nodi max	Descrizione	Comando inviato
1	Lifeline	5	Gruppo Life Line	Windows Covering report, Switch Multilevel report, Device Reset Locally Notification, Notification Report, Indicator Report, Configuration Report
2	Follow-me	5	The device in this group will follow the device level.	Basic Set
3	Scene Activation	5	Receive an activation Scene ID if an obstacle are reach during its operation. The scene Id can be define by using parameters 30, 31.	Scene Activation Set

 **INFO:** Association ensures direct transfer of control commands between devices, and is performed without participation of the main controller.

 **TIP:** To avoid network delays, we recommend limiting the amount of associated devices to no more than 5 per group.

CONFIGURATIONS

SCENE ACTIVATION

Parameter No. 30: OPEN_COLLISION_SCENE_ID (2 byte), simple.

Scene ID sent if a collision is detected during opening operation.

Configuration	Result
0 (Default value)	Do not send the scene activation
From 1 to 254	The scene ID sent for the collision during opening

Parameter No. 31: CLOSE_COLLISION_SCENE_ID (2 byte), simple.

Scene ID sent if a collision is detected during closing

Configuration	Result
0 (Default value)	Do not send the scene activation
From 1 to 254	The scene ID sent for the collision during closing

Parameter No. 37: LEVEL_REPORT_PERIOD (2 byte), advanced.

Used to define the level report frequency when the motor is moving. Valid values are from 2 (report updated every 2 seconds) to 60 (report updated every 60 seconds).

Configuration	Result
From 2 to 60	Time between reports in seconds
5 (Default value)	

Parameter No. 38: SEND_MULTILEVEL_REPORT (1 byte), advanced.

For backward compatibility the device can send the multilevel report together with the Switch Multilevel report in addition to the update with Windows Covering report.

Configuration	Result
0 (Default value)	Multilevel report will not be sent
1	Multilevel report will be sent

IT DICHIARAZIONE DI CONFORMITÀ UE

CE CHERUBINI S.p.A. dichiara che il prodotto è conforme alle pertinenti normative di armonizzazione dell'Unione:

Direttiva 2014/53/UE, Direttiva 2011/65/UE.

Il testo completo della dichiarazione di conformità UE è disponibile facendone richiesta sul sito: www.cherubini.it.

EN EU DECLARATION OF CONFORMITY

CE CHERUBINI S.p.A. declares that the product is in conformity with the relevant Union harmonisation legislation:

Directive 2014/53/EU, Directive 2011/65/EU.

The full text of the EU declaration of conformity is available upon request at the following website: www.cherubini.it.

DE EU-KONFORMITÄTSERKLÄRUNG

CE CHERUBINI S.p.A. erklärt der produkt erfüllt die einschlägigen Harmonisierungsrichtsvorschriften der Union:

Richtlinie 2014/53/EU, Richtlinie 2011/65/EU.

Der vollständige Text der EU-Konformitätserklärung kann unter unserer Web-Seite www.cherubini.it, gefragt werden.

FR DÉCLARATION UE DE CONFORMITÉ

CE CHERUBINI S.p.A. déclare que le produit est conforme à la législation d'harmonisation de l'Union applicable:

Directive 2014/53/UE, Directive 2011/65/UE.

Le texte complet de la déclaration UE de conformité est disponible en faisant requête sur le site internet: www.cherubini.it.

ES DECLARACIÓN UE DE CONFORMIDAD

CE CHERUBINI S.p.A. declara que el producto es conforme con la legislación de armonización pertinente de la Unión:

Diretiva 2014/53/UE, Directiva 2011/65/UE.

El texto completo de la declaración UE de conformidad puede ser solicitado en: www.cherubini.it.

CHERUBINI S.p.A.

Via Adige 55
25081 Bedizzole (BS) - Italy
Tel. +39 030 6872.039 | Fax +39 030 6872.040
info@cherubini.it | www.cherubini.it

CHERUBINI Iberia S.L.

Avda. Unión Europea 11-H
Apdo. 283 - P. I. El Castillo
03630 Sax Alicante - Spain
Tel. +34 (0) 966 967 504 | Fax +34 (0) 966 967 505
info@cherubini.es | www.cherubini.es

CHERUBINI France S.a.r.l.

ZI Du Mas Barbet
165 Impasse Ampère
30600 Vauvert - France
Tél. +33 (0) 466 77 88 58 | Fax +33 (0) 466 77 92 32
info@cherubini.fr | www.cherubini.fr

CHERUBINI Deutschland GmbH

Siemensstrasse, 40 - 53121 Bonn - Deutschland
Tel. +49 (0) 228 962 976 34 / 35 | Fax +49 (0) 228 962 976 36
info@cherubini-group.de | www.cherubini-group.de

