



MOTORE TUBOLARE CON FINECORSO ELETTRONICO
PER TENDE TECNICHE E SCEN

IT

TUBULAR MOTOR WITH ELECTRONIC LIMIT SWITCH
FOR SCREENS

EN

SCREENS - ROHRMOTOR MIT
ELEKTRONISCHER ENDLAGENEINSTELLUNG

DE

MOTEUR TUBULAIRE POUR STORES TECHNIQUES ET SCREENS
AVEC CONTACT DE FINS DE COURSE ÉLECTRONIQUES

FR

MOTOR TUBULAR PARA CORTINA ENROLLABLE Y SCREEN
CON FIN DE CARRERA ELECTRÓNICO

ES

Table of contents:

How to prepare the motor	p. 25
Electrical connections	p. 26
Compatible remote controls	p. 27
Key to symbols	p. 27
Command sequences example	p. 28
Function open/close programming remote control	p. 29-30
Setting the first remote control	p. 31
Automatic disabling of the first remote control setting function	p. 31
Adjustment of the limit switches	p. 32
Setting the closing limit switch	p. 32
Setting the opening limit switch	p. 32
Deleting the limit switch positions	p. 33
Deleting the closing limit switch	p. 33
Deleting the opening limit switch	p. 33
Total deleting of the limit switches	p. 33
Setting a middle position	p. 34
Deleting the middle position	p. 34
Closing force adjustment	p. 35
Setting of additional remote controls	p. 36
Remote control memory clearing	p. 36
Full memory clearing	p. 37
Special functions	
Additional middle position	p. 38
Setting the additional middle position	p. 38
Changing the additional middle position	p. 39
Deleting the additional middle position	p. 39
Short-term setting of a remote control	p. 39
Setting the A530058 pocket remote control	p. 40
Fabric tightening function	p. 41
Electric wiring to motor command for UP-DOWN mode (2 independent UP-DOWN buttons)	p. 42
Command management from white wire	p. 43
Super-sensitivity obstacle detection management during downwards movement (only for motors up to 20 Nm)	p. 44
EU Declaration of conformity	p. 108

HOW TO PREPARE THE MOTOR

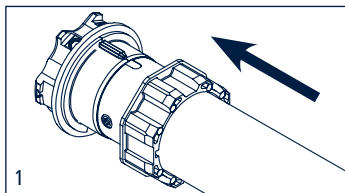
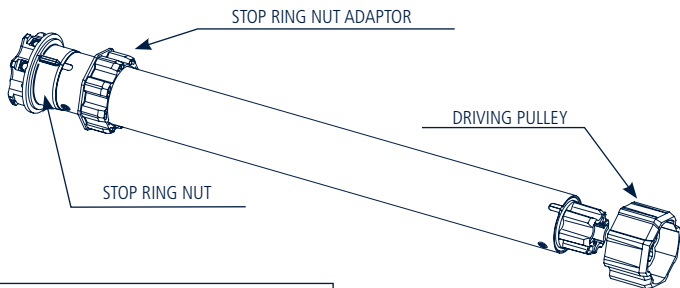

1. Insert the adaptor in the stop ring nut mating the groove with the reference notch and push till they touch.

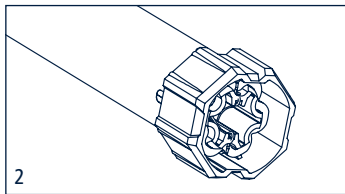

2. Fix the driving pulley on the motor pin until the stop pin clicks.

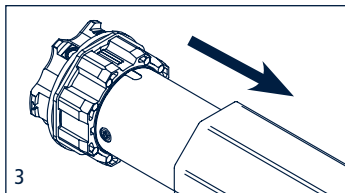

3. Insert the motor fully in the rolling tube.

NB: If you use tubes with a round form, the driving pulley must be fixed to the tube, and the installation is to be paid by the person who installs the system. For other tube sections the fitting is optional, but strongly recommended.

ELECTRICAL CONNECTIONS

- In order to prevent dangerous situations or malfunctioning, the electrical command elements wired to the motor must be sized according to the motor's electrical features.
- Means for disconnection must be incorporated in the fixed wiring in accordance with the national installation standards.
- For outdoor use, provide the appliance with a supply cable with designation H05RN-F containing at least 2% of carbon.
- If not used, the white wire must be insulated. It is dangerous to touch the white wire when the motor is powered.

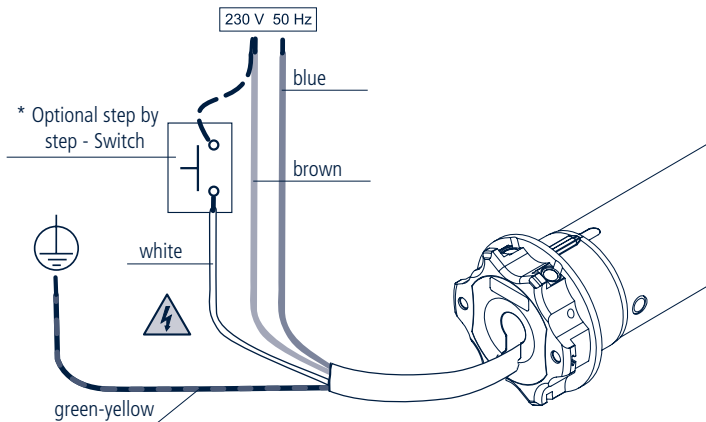

* Installing this button is optional. The connection can be done differently using the brown wire or the blue wire. The button affords the possibility to command the motor in stepping mode (up, stop, down, stop, up, stop, down, stop..)

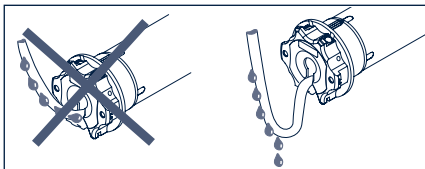

COMPATIBLE REMOTE CONTROLS

GIRO

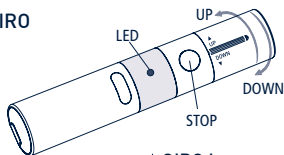

GIRO Wall

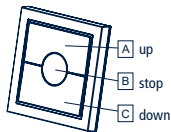

GIRO Plus

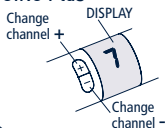

GIRO Lux

Activating the Sun sensor

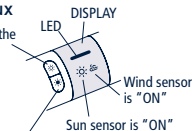

Deactivating the Sun sensor

GIRO P-Lux

Change channel

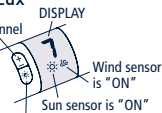

Activating/ Deactivating the Sun sensor

POP

POP Lux

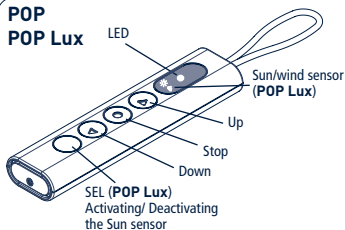

POP Plus

POP P-Lux

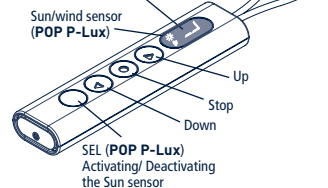

SKIPPER
SKIPPER P-Lux
SKIPPER PLUS
SKIPPER Lux

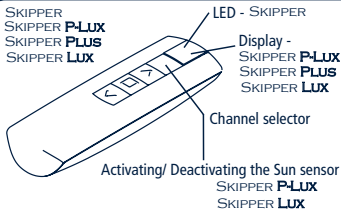

SKIPPER LCD
SKIPPER SENSO

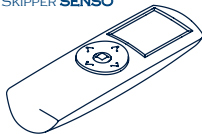

Check the specific instruction book

A530058 Remote Control with 4 independent channels



KEY TO SYMBOLS

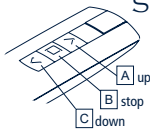
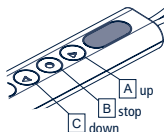
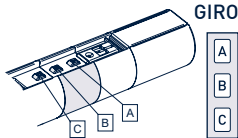

KEY TO SYMBOLS

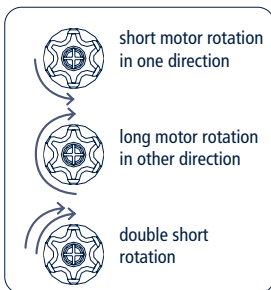
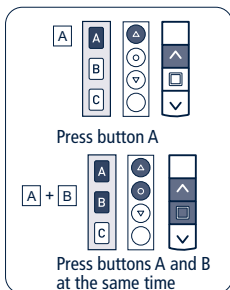
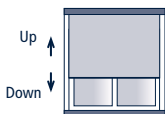

COMMAND SEQUENCES EXAMPLE

Most of the command sequences have three distinct steps, at the end of which the motor indicates if the step has been concluded positively or not, by turning in different ways. This section is provided to demonstrate the motor indications. The buttons must be pressed as shown in the sequence, without taking more than 4 seconds between one step and the next. If more than 4 seconds are taken, the command is not accepted and the sequence must be repeated. Command sequence example:

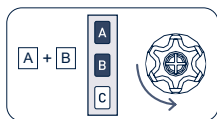

Step 1

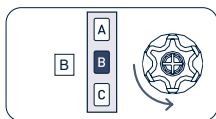

Step 2

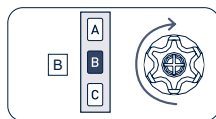

Step 3

As we can see from the example, when the sequence ends positively, the motor returns to its starting position in one long rotation. In fact, two short rotations in the same direction correspond to one long rotation in the opposite direction. The motor returns to the starting position even when the sequence is not completed; in this case by performing one or two short rotations. Example of a wrong sequence:

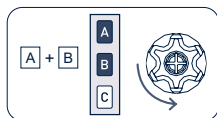

Step 1

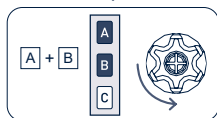

Step 1

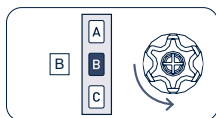

Step 2



FUNCTION OPEN/CLOSE PROGRAMMING

REMOTE CONTROL SKIPPER PLUS - SKIPPER LUX - SKIPPER P-LUX

REMOTE CONTROL POP PLUS - POP LUX - POP P-LUX

To prevent accidental changes to the programming of the motor during the daily use of the remote control, the possibility of programming is disabled automatically 8 hours after sending the last sequence (A+B or B+C).

CHECKING THE STATUS OF THE FUNCTION

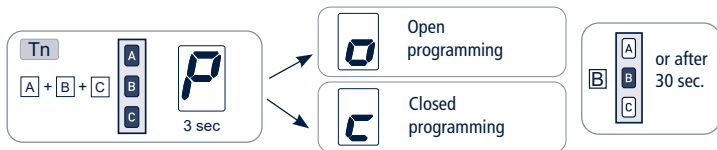

To change the status of the function, see the sequences "ENABLE/DISABLE PROGRAMMING".

ENABLE PROGRAMMING

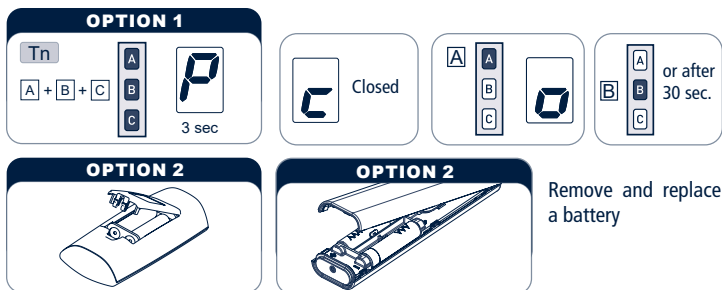

Remove and replace a battery

Proceed with programming as the instructions booklet.

DISABLE PROGRAMMING



FUNCTION OPEN/CLOSE PROGRAMMING

REMOTE CONTROL SKIPPER - SERIES GIRO - REMOTE CONTROL POP

To prevent accidental changes to the programming of the motor during the daily use of the remote control, the possibility of programming is disabled automatically 8 hours after sending the last sequence (A+B or B+C).

CHECKING THE STATUS OF THE FUNCTION

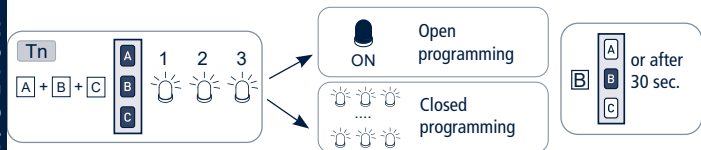

To change the status of the function, see the sequences "ENABLE/DISABLE PROGRAMMING".

ENABLE PROGRAMMING

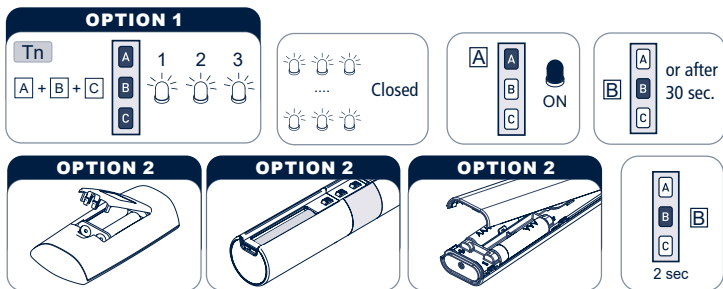

Remove one battery and wait minimum 5 seconds or press any button.

Proceed with programming as the instructions booklet.

DISABLE PROGRAMMING



SETTING THE FIRST REMOTE CONTROL

This operation can only be performed when the motor is new, or after a total delete of the memory.

During this step, power up only one motor at time!

T1: First remote control to be set

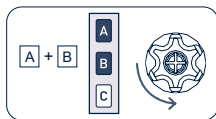

T1

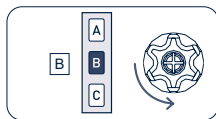

T1

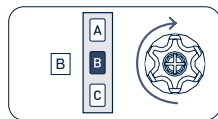

T1 (2 sec)

AUTOMATIC DISABLING OF THE FIRST REMOTE CONTROL SETTING FUNCTION

Every time you connect the power supply to the motor, you have 3 hours to store the first remote control. After this time, the ability to store the remote control is disabled. To reset the timer of the function you have to disconnect and reconnect the power supply to the motor.

SETTING OF THE LIMIT SWITCHES

Tubular motors have an electronic limit switch system with an encoder. This system ensures great reliability and precision in keeping the positions. Limit switch regulation is performed simply with the remote control. During setting, the motor moves only as long as the up or down button is pressed, stopping when the button is released.

At the end of setting, press either the up or down button briefly to move the motor.

SETTING THE CLOSING LIMIT SWITCH

After setting the remote control, it's necessary to set first the closing position!

For cassette-awnings, hold the button pressed until the motor stops automatically on the closing position. For open awnings, hold the button pressed and drive until the necessary closing position.

Notes: - If the awning is completely closed, you have firstly to open it by around 20 cm.
- Because the correct rotation direction will be identified only after the closing position is set, to close the awning, during setting the closing position, it's sometimes necessary to use the "down" button.

To set the closing position, hold pressed the "stop" button (around 2 sec) until the motor performs a short "down" movement.

Tn: Already programmed remote control

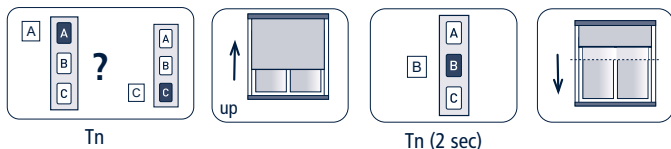

SETTING THE OPENING LIMIT SWITCH

After setting the closing position, open the awning until the necessary opening position by pressing the "down" button. You can use the "up"/"down" buttons to precisely set the opening position (in applications pergolas that allow this, you must press and hold the button until the motor stops automatically to the maximum opening).

To set the opening position, hold pressed the "stop" button (around 2 sec) until the motor performs a short "up" movement.

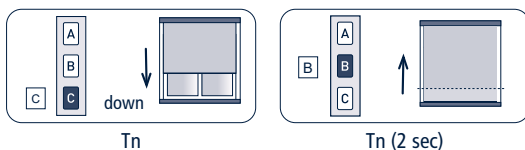

DELETING THE LIMIT SWITCH POSITIONS

DELETING THE CLOSING LIMIT SWITCH

To delete only the closing limit switch perform the following steps and proceed with "SETTING THE CLOSING LIMIT SWITCH".

Tn: Already programmed remote control

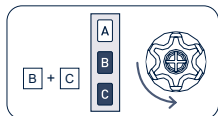

Tn

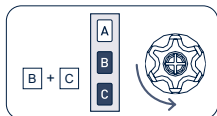

Tn

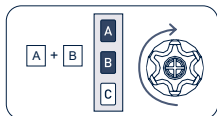

Tn (2 sec)

DELETING THE OPENING LIMIT SWITCH

To delete only the opening limit switch perform the following steps and proceed with "SETTING THE OPENING LIMIT SWITCH".

Tn: Already programmed remote control

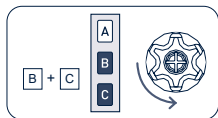

Tn

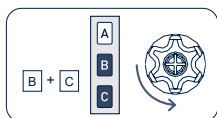

Tn

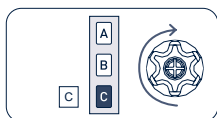

Tn (2 sec)

TOTAL DELETING OF THE LIMIT SWITCHES

Tn: Already programmed remote control

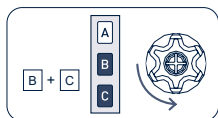

Tn

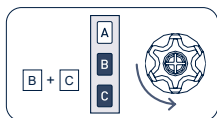

Tn

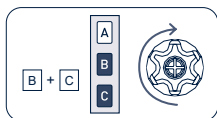

Tn (4 sec)

NB: by deleting the limit switches, the setting of the closing force is maintained (see p. 35).

SETTING A MIDDLE POSITION

This function allows to drive the awning to a favourite middle position. When this middle position is memorized, just press the STOP button for 2 seconds and automatically the motor will move the awning to this position.

To memorize the middle position, move the awning to the desired position and then hold the STOP button down (for about 4 seconds) until the motor gives confirmation.

Tn: Already programmed remote control

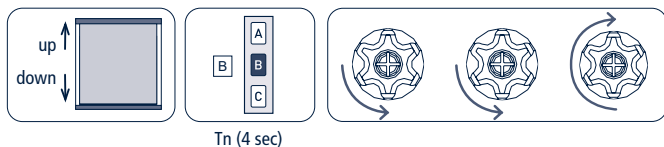

DELETING THE MIDDLE POSITION

If you want to delete the middle position, it can be done as described below. To change this position, it's also necessary to delete first the memorized middle position.

Before deleting the middle position, the awning must go to the middle position by pressing the STOP button for 2 second, then press the STOP button again (for about 4 seconds) until the motor performs the confirmation movement.

Tn: Already programmed remote control

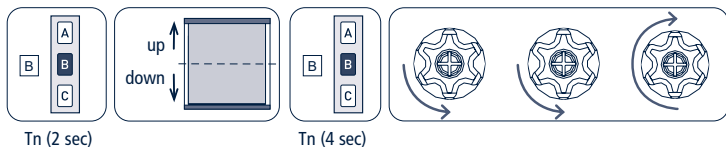

CLOSING FORCE ADJUSTMENT

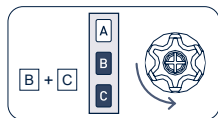

Tn

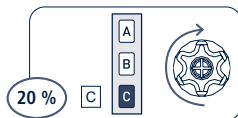
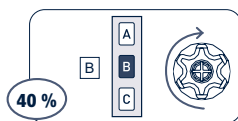
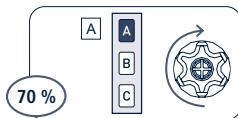
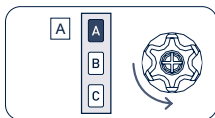

2 sec

This system, the only one of its kind, guarantees that cassette-awnings remain perfectly closed, without any danger of the canvas suffering excessive traction. The system works in all kinds of applications, thanks to the possibility of manually adjusting the closing force. The motor is factory set to a closing force of 40% of the nominal torque (e.g.: 40% of 50 Nm = 20 Nm). This force can be changed very easily by the remote control. It can be reduced by 20% or increased up to 70%, depending on the desired result.

SETTING OF ADDITIONAL REMOTE CONTROLS

Up to 15 remote controls can be set, including the light/wind sensor.

Tn: Already programmed remote control

Tx: Additional remote control

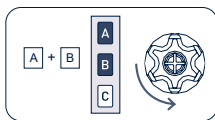

Tn

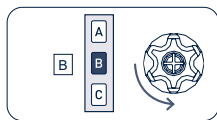

Tn

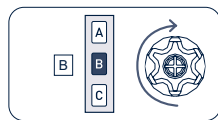

Tx (2 sec)

REMOTE CONTROL MEMORY CLEARING

It is possible to delete singly all the memorized remote controls. When the last one is deleted the motor initial condition is restored. The same applies to the single channels of a multichannel remote control: just select the channel to cancel.

Tn: Remote control to be cleared

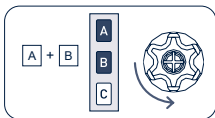

Tn

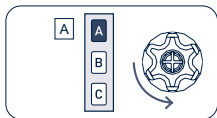

Tn

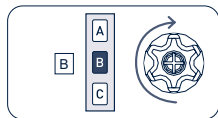

Tn (2 sec)

FULL MEMORY CLEARING

This full memory clearing does not delete the setting of the limit switch.

The full memory clearing can be performed in two ways:

1) WITH THE REMOTE CONTROL

Tn: Already programmed remote control

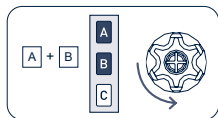

Tn

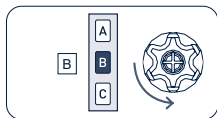

Tn

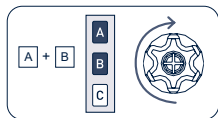

Tn (4 sec)

2) WITH THE WHITE WIRE

Do this operation only in case of emergency, if all remote controls are no longer operating.

To delete the memory we have to access the white wire of the motor.

The sequence of this operation is the following:

- 1) Disconnect the power supply from the motor, via the main switch for example.
- 2) Connect the white motor wire to the brown wire (phase) or to the blue wire (neutral).
- 3) Connect the power supply to the motor, which rotates briefly in one direction.
- 4) Disconnect the power supply from the motor for at least 4 seconds.
- 5) Connect the power supply to the motor which performs one brief rotation in one direction after around 4 seconds and then a longer one in the opposite direction.
- 6) Disconnect the power supply from the motor.
- 7) Separate the white wire from the brow/blue wire. Insulate the white wire, in an appropriate way, before reconnecting the power supply.

At this point it is possible to proceed with the setting of the first remote control.

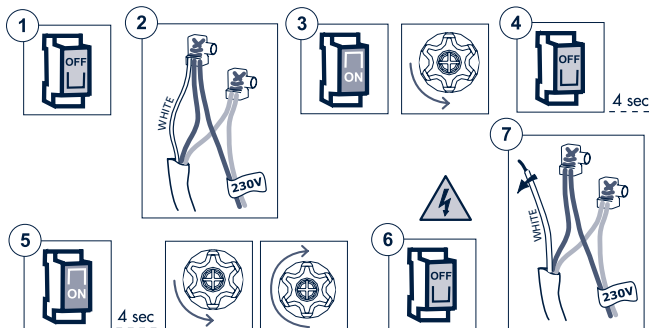

SPECIAL FUNCTIONS

ADDITIONAL MIDDLE POSITION

The additional middle position is useful to open the awning automatically through the WindTec Lux sensor and to bring it to a middle position when the light of the environment exceeds the threshold set. This additional middle position can be used only in combination with the light automatism of the WindTec Lux sensor.

The awning cannot be brought to this position with the remote control.

However, there is the possibility to program the current middle position using the B button (2 sec) command. If the additional middle position is not memorized, the light automatism of the WindTec Lux sensor (when enabled) opens the awning completely. When the WindTec Lux (Set button) sensor is tested, the movements of the motor do not take the additional middle position into consideration: the awning always stops in the half-way position and opens completely if the light exceeds the threshold value.

SETTING THE ADDITIONAL MIDDLE POSITION

After saving the limit switches, carry out the following command sequence:

Tn: Already programmed remote control

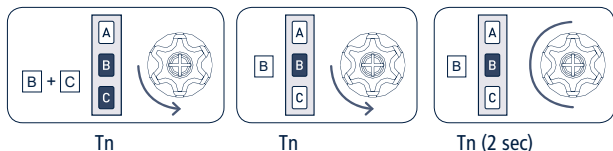

Starting from this moment, the motor moves in the "DEAD MAN" mode. This makes it possible to regulate the additional middle position in a precise way.

Carry out the following operations:

- Bring the awning to the desired open position.
- Press the B button of the remote control for about 2 seconds, until the motor gives a confirmation signal.

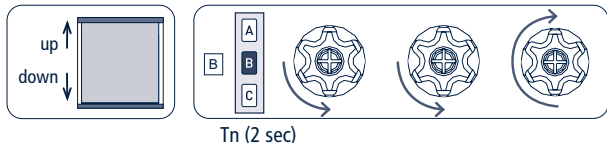

Starting from this moment, when the WindTec Lux commands the opening of the awning through the light automatism (if this is enabled), the awning will be brought to the additional middle position.

CHANGING THE ADDITIONAL MIDDLE POSITION

To change the additional middle position repeat the procedure described in the previous section.

DELETING THE ADDITIONAL MIDDLE POSITION

Carry out the following command sequence in order to cancel the additional middle position:

Tn: Already programmed remote control

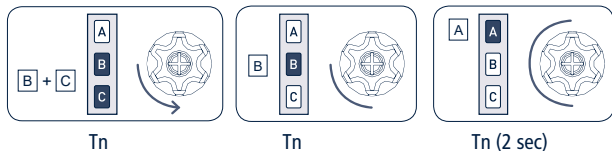

SHORT-TERM SETTING OF A REMOTE CONTROL

This function makes it possible to store a remote control temporarily, for example, with the purpose of setting the limit switches during assembly in the factory. A later final saving of the remote control will be possible using the appropriate command sequence (see: "SETTING THE FIRST REMOTE CONTROL"). The operations described below can be carried out only when the motor has just come out of the factory or after a full memory clearing (see: "FULL MEMORY CLEARING"). The motor makes the following operations possible only within the time limits described in order to make sure that the short-term setting is used only in the installation or factory setting phase and not during daily use.

Power up the motor, make sure that no other motors having an empty memory are powered up in the same operating range.

Within 30 seconds after start, press the B and C buttons simultaneously until the motor gives a confirmation signal.

The remote control will remain stored for 5 minutes, while the motor is powered up. After 5 minutes or when the motor has its power cut off, the remote control will be cancelled.

T1: First remote control to be set

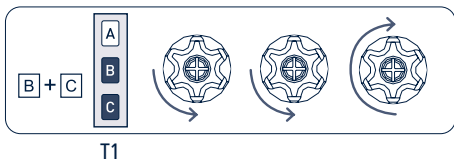

SETTING THE A530058 POCKET REMOTE CONTROL

NB: The new pocket remote control can be set only after programming of a previous remote control as the traditional Cherubini remote controls (Skipper, Giro or POP - 3 buttons Up-Down-Stop remote control).

HOW TO PROCEED TO SET THE BUTTON ON THE POCKET REMOTE CONTROL

Tn: Already programmed remote control

Tx: Pocket remote control to be set

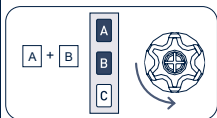

Tn

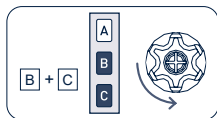

Tn

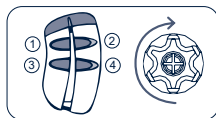

Tx (2 sec)

After to have pressed for minimal 2 seconds one of the 4 buttons on the pocket remote control, this one will be memorized on the step-by-step mode (UP-STOP-DOWN-STOP). The following buttons will be not memorized and have to be done with previous described sequence, and could be used to move additional motors.

DELETING ONE BUTTON ON THE POCKET REMOTE CONTROL

The buttons saved may be deleted individually according to the following sequence:

Tn: Already programmed remote control

Tx: Pocket remote control with button to be deleted

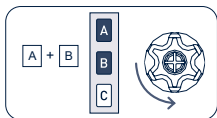

Tn

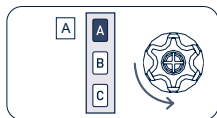

Tn

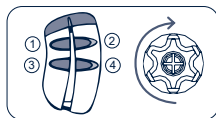

Tx (2 sec)

To confirm the operation the motor will do a short shunt and the button, which has to be pressed for minimal 2 second, will be deleted.

FABRIC TIGHTENING FUNCTION

By programming this function, the motor after reaching the outer limit, automatically performs a short backwards turn to tighten the fabric. Specially designed for pergolas and horizontal awnings.

N.B: The programming of this option can be made only after setting the limit switches.

STARTING THE SETTING PROCEDURE:

Tn: Already programmed remote control

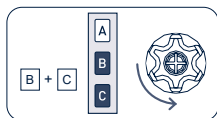

Tn

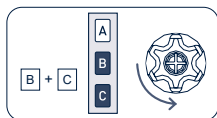

Tn

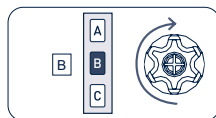

Tn (2 sec)

This first process brings the awning to the open position and sets the motor into "DEAD MAN" operating mode. Thereafter, the fabric tensioning position can be adjusted accurately.

ADJUSTMENT AND CONFIRMATION OF THE TENSIONING POSITION

Tn: Already programmed remote control

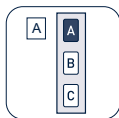

Tn

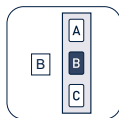
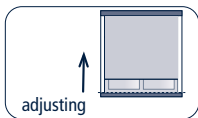

Tn (2 sec)

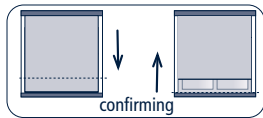

After adjusting and confirming the tensioning position, the motor drives to the open position and returns to the new tensioning position which has just been confirmed. From this moment, each time the motor reaches the open position, automatically it will turn back to the "tensioning position".

DELETING THE TENSIONING POSITION

Tn: Already programmed remote control

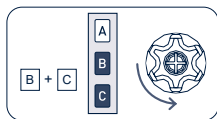

Tn

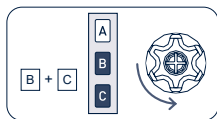

Tn

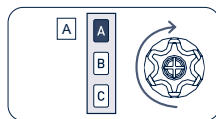

Tn (2 sec)

ELECTRIC WIRING TO MOTOR COMMAND FOR UP-DOWN MODE (2 independent UP-DOWN buttons)

To connect the switch, use only kind of switches with mechanical or electrical interlock, to prevent to press both buttons at same time.

The motor automatically recognizes the switch-type (with 1 or 2 buttons) and sets the proper operational mode.

ENGLISH

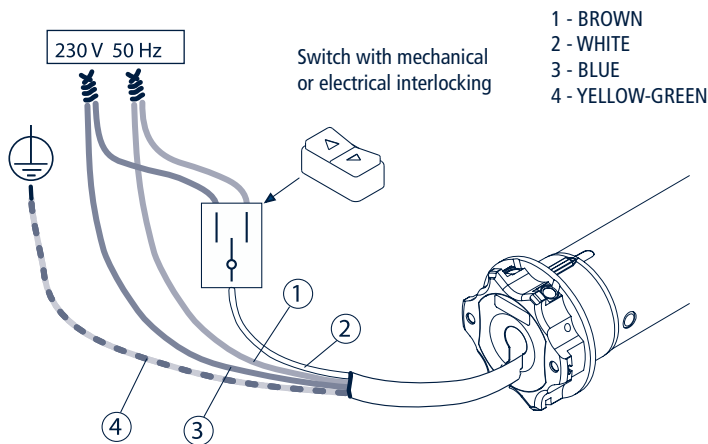

WIRE PROGRAMMING

Using the switch as described on this page it's possible to set the motor trough the white wire (wire programming). To find out this procedure, require the instruction pamphlet from your dealer.

COMMAND MANAGEMENT FROM WHITE WIRE

UP-STOP-DOWN-STOP / UP-DOWN / UP-DOWN "DEAD MAN"

NB: The default function provided in the motors leaving the factory is UP-STOP-DOWN-STOP for singular UP/DOWN button switch. (Not for the switch with two independent UP-DOWN buttons!)

PROCEDURE TO CHANGE THE CONTROL MODE:

Tn: Already programmed remote control

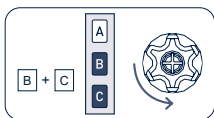

Tn

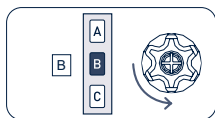

Tn

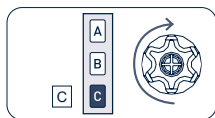

Tn (2 sec)

The possible settings are 3 and are available in the following order:

- UP-STOP-DOWN-STOP (factory setting)
- UP-DOWN (for 2 independent buttons)
- UP-DOWN "DEAD MAN" (for 2 independent buttons)

To switch from one setting to the following, perform the sequence as many times as necessary to reach the desired setting.

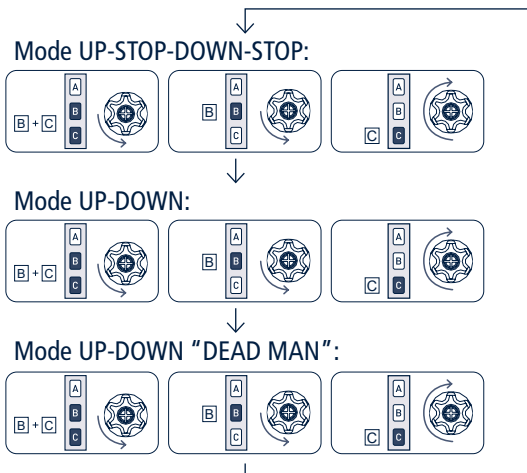

SUPER-SENSITIVITY OBSTACLE DETECTION MANAGEMENT DURING DOWNWARDS MOVEMENT (only for motors up to 20 Nm)

Where required - for example for window screens or screen fabric with a tensioner weight attached - it is possible to activate/deactivate a high level of obstacle detection sensitivity during downwards movement.

ACTIVATING THE SUPER-SENSITIVITY FUNCTION

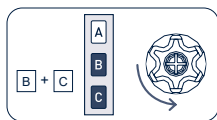

Tn

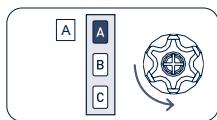

Tn

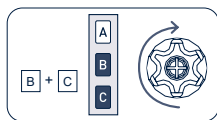

Tn (2 sec)

SETTING AND REGULATING THE SUPER-SENSITIVITY FUNCTION ON 3 LEVELS

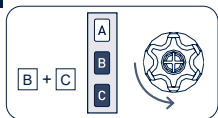

Tn

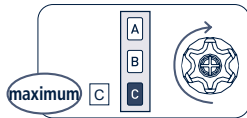
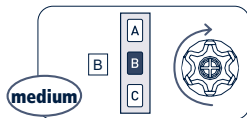
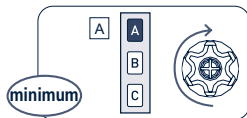
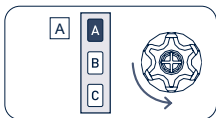

2 sec

DEACTIVATING THE SUPER-SENSITIVITY FUNCTION

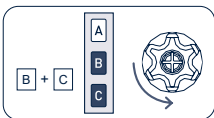

Tn

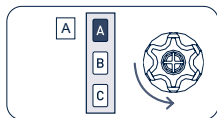

Tn

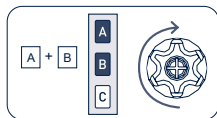

Tn (2 sec)

IT DICHIARAZIONE DI CONFORMITÀ UE

CE CHERUBINI S.p.A. dichiara che il prodotto è conforme alle pertinenti normative di armonizzazione dell'Unione:

Direttiva 2014/53/UE, Direttiva 2011/65/UE.

Il testo completo della dichiarazione di conformità UE è disponibile facendone richiesta sul sito: www.cherubini.it.

EN EU DECLARATION OF CONFORMITY

CE CHERUBINI S.p.A. declares that the product is in conformity with the relevant Union harmonisation legislation:

Directive 2014/53/EU, Directive 2011/65/EU.

The full text of the EU declaration of conformity is available upon request at the following website: www.cherubini.it.

DE EU-KONFORMITÄTSERKLÄRUNG

CE CHERUBINI S.p.A. erklärt der produkt erfüllt die einschlägigen Harmonisierungsrechtsvorschriften der Union:

Richtlinie 2014/53/EU, Richtlinie 2011/65/EU.

Der vollständige Text der EU-Konformitätserklärung kann unter unserer Web-Seite www.cherubini.it, gefragt werden.

FR DÉCLARATION UE DE CONFORMITÉ

CE CHERUBINI S.p.A. déclare que le produit est conforme à la législation d'harmonisation de l'Union applicable:

Directive 2014/53/UE, Directive 2011/65/UE.

Le texte complet de la déclaration UE de conformité est disponible en faisant requête sur le site internet: www.cherubini.it.

ES DECLARACIÓN UE DE CONFORMIDAD

CE CHERUBINI S.p.A. declara que el producto es conforme con la legislación de armonización pertinente de la Unión:

Diretiva 2014/53/UE, Directiva 2011/65/UE.

El texto completo de la declaración UE de conformidad puede ser solicitado en: www.cherubini.it.

CHERUBINI S.p.A.

Via Adige 55
25081 Bedizzole (BS) - Italy
Tel. +39 030 6872.039
info@cherubini.it | www.cherubini.it

CHERUBINI Iberia S.L.

Avda. Unión Europea 11-H
Apdo. 283 - P. I. El Castillo
03630 Sax Alicante - Spain
Tel. +34 (0) 966 967 504 | Fax +34 (0) 966 967 505
info@cherubini.es | www.cherubini.es

CHERUBINI France SAS

ZI Du Mas Barbet
165 Impasse Ampère
30600 Vauvert - France
Tél. +33 (0) 466 77 88 58
info@cherubini.fr | www.cherubini.fr

CHERUBINI Deutschland GmbH

Siemensstrasse, 40 - 53121 Bonn - Deutschland
Tel. +49 (0) 228 962 976 34 / 35 | Fax +49 (0) 228 962 976 36
info@cherubini-group.de | www.cherubini-group.de

