

# CHERUBINI

## PLUG&PLAY SILENT

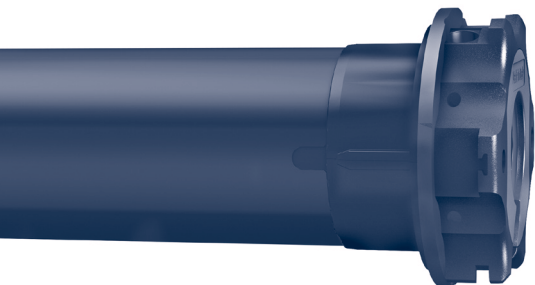

MOTORE TUBOLARE SILENZIOSO CON  
REGOLAZIONE AUTOMATICA DEL FINECORSA ELETTRONICO

IT

SILENT TUBULAR MOTOR WITH AUTOMATIC ADJUSTMENT  
OF THE ELECTRONIC LIMIT SWITCH

EN

GERÄUSCHARMER ROHRMOTOR MIT AUTOMATISCHER  
EINSTELLUNG DER ELEKTRONISCHEN ENDLAGEN

DE

MOTEUR TUBULAIRE SILENCIEUX AVEC RÉGLAGE AUTOMATIQUE  
DES FINS DE COURSE ÉLECTRONIQUES

FR

MOTOR TUBULAR SILENCIOSO CON REGULACIÓN AUTOMÁTICA  
DEL FIN DE CARRERA ELECTRONICO

ES



ISTRUZIONI - INSTRUCTIONS - EINSTELLANLEITUNGEN  
INSTRUCTIONS - INSTRUCCIONES



**Table of contents:**

Electrical connections .....	p. 11
How to prepare the motor .....	p. 12
Instruction for use .....	p. 13
Key to symbols .....	p. 14
Command sequences example .....	p. 14
Changing limit switches .....	p. 15
Deleting of single limit switch positions .....	p. 15
Deleting of all limit switch positions .....	p. 15
Motor operation.....	p. 16
Restoring the original configuration .....	p. 16

**EU DECLARATION OF CONFORMITY**

CHERUBINI S.p.A. declares that the product is in conformity with the relevant Union harmonisation legislation:

Directive 2014/35/EU

Directive 2014/30/EU

Directive 2011/65/EU

The full text of the EU declaration of conformity is available upon request at the following website: [www.cherubini.it](http://www.cherubini.it).

## ELECTRICAL CONNECTIONS

- To prevent any danger or malfunction, the size of electrical control components connected to the motor must be compatible with the electrical features of the motor.
- Means for disconnection must be incorporated in the fixed wiring in accordance with the national installation standards.
- For outdoor use, provide the appliance with a supply cord with designation H05RN-F containing at least 2% of carbon.
- Cable length between motor and control-switch maximal 50 m.  
In case of cable length more than 50 m an interface-relay have to be used.

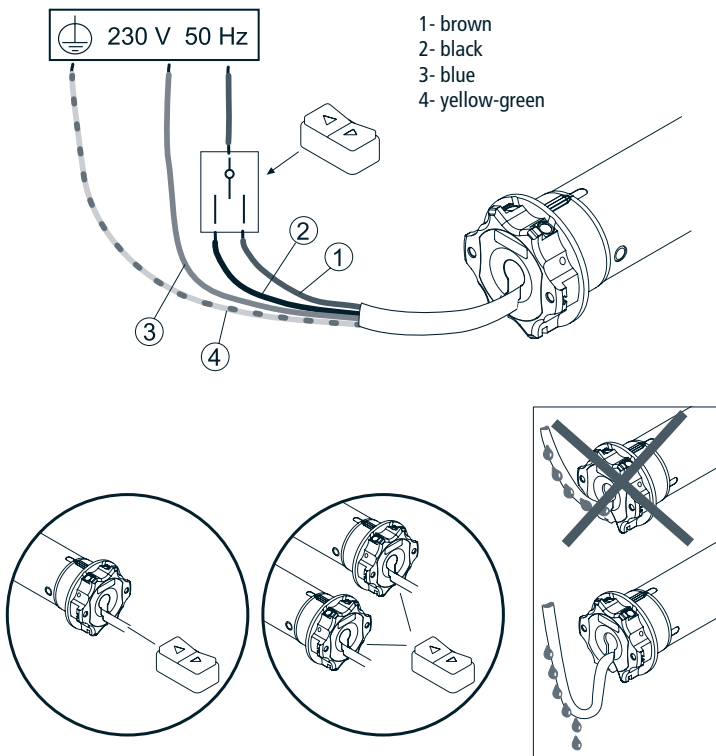

## HOW TO PREPARE THE MOTOR

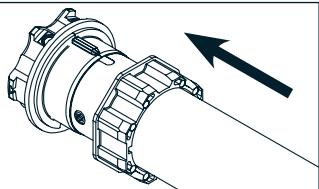
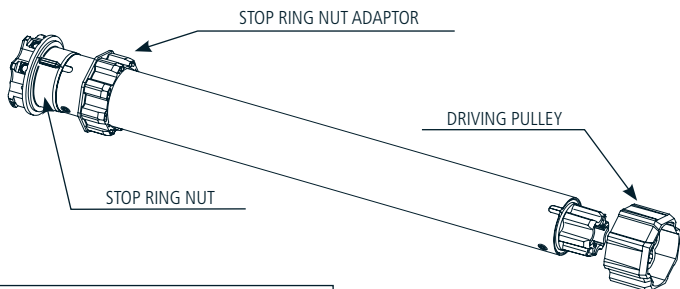

1. Insert the adaptor in the stop ring nut mating the groove with the reference notch and push till they touch.

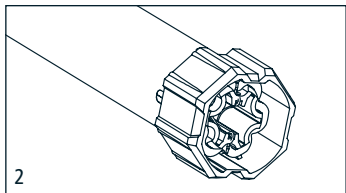

2. Fix the driving pulley on the motor pin until the stop pin clicks.

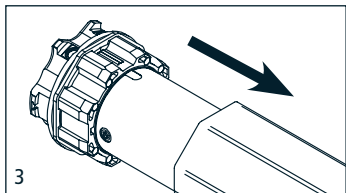

3. Insert the motor fully in the rolling tube.

**NB:** If you use tubes with a round form, the driving pulley must be fixed to the tube, and the installation is to be paid by the person who installs the system. For other tube sections the fitting is optional, but strongly recommended.

## INSTRUCTION FOR USE

The tubular motor is very simple to be used and installed, it does not need any regulation as it automatically detects the position of limit switch.

The rolling shutter must be equipped with:

A - security locks or stiff fixing springs,

B - fixed or removable stoppers for end slats.

It is very important to check the sturdiness of the rolling shutter.

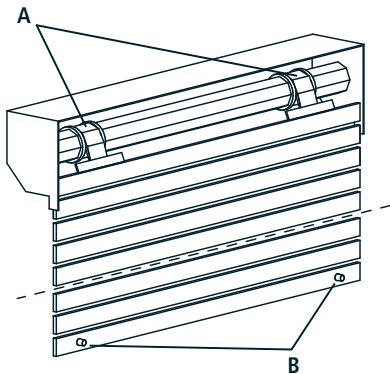

## KEY TO SYMBOLS

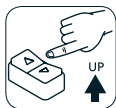

Press the  
UP-button

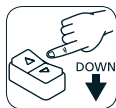

Press the  
DOWN-button

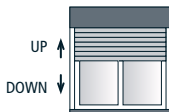

ENGLISH

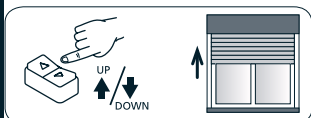

Press the up or down buttons to raise  
the blind.



Press the buttons as indicated in rapid sequence and hold the button  
down at the step marked by "HOLD", to check the motor confirmation  
movement.

## COMAND SEQUENCES EXAMPLE

Most of the command sequences have three or six distinct steps.  
The buttons should be pressed quickly ( $<0.5$  sec) as indicated in the sequence.  
The time interval between each step should not be more than 1 second, otherwise the  
command sequence will be cancelled.  
To receive confirmation that the sequence has been accepted by the motor, the button  
must be held down at the final step marked by HOLD.

Command sequence example in 6 steps:

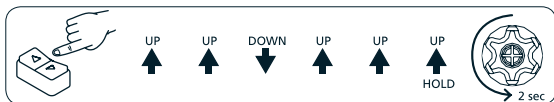

**Attention!** If the sequence requires a repetition of the same commands  
(Up+Up/Down+Down), an interposition of the Stop position could be necessary  
depending on the type of switch in use.

## CHANGING LIMIT SWITCHES

The following command sequences may be performed only after the limit switches have been learned and only when the motor is completely on one of the two limit switch positions: either lower or upper limit positions.

### DELETING OF SINGLE LIMIT SWITCH POSITIONS

Deleting the UPPER limit starting from the UPPER limit switch position

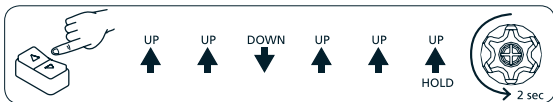

Deleting the LOWER limit starting from the LOWER limit switch position

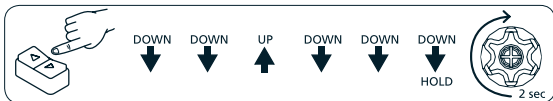

### DELETING OF ALL LIMIT SWITCH POSITIONS

Deleting both limit switch position starting from the UPPER limit

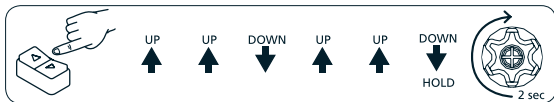

Deleting both limit switch position starting from the LOWER limit

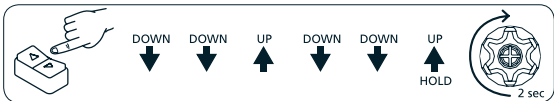



## MOTOR OPERATION

	STOP AT LIMIT SWITCH (OPENING AND CLOSING)	OBSTACLE DETECTION DURING MOVEMENT
Plug&Play	It always reaches the limit switch and then slightly reverses itself to decrease the force.	It stops and slightly reverses itself to decrease the force.

When an obstacle is detected in one direction, the movement is inhibited in that direction. Please operate the motor in the opposite direction to restore normal operation.

## RESTORING THE ORIGINAL CONFIGURATION

**PLEASE NOTE: recovery of the default configuration will delete the limit switches.**

To restore the original motor configuration perform the procedure as described below:

- Connect both the brown and black motor wires under the same switch, e.g. UP.

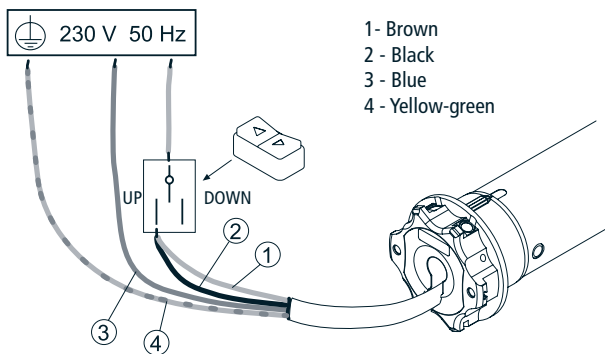

- Press the UP button for at least 2 seconds.
- Disconnect and then restore the original control switch electrical connections (see page 11).

## Note - Bem - Notes - Notas:

A series of 20 horizontal dotted lines for writing notes.



**CHERUBINI S.p.A.**

Via Adige 55  
25081 Bedizzole (BS) - Italy  
Tel. +39 030 6872.039  
info@cherubini.it | www.cherubini.it

**CHERUBINI Iberia S.L.**

Avda. Unión Europea 11-H  
Apdo. 283 - P. I. El Castillo  
03630 Sax Alicante - Spain  
Tel. +34 (0) 966 967 504 | Fax +34 (0) 966 967 505  
info@cherubini.es | www.cherubini.es

**CHERUBINI France SAS**

ZI Du Mas Barbet  
165 Impasse Ampère  
30600 Vauvert - France  
Tél. +33 (0) 466 77 88 58  
info@cherubini.fr | www.cherubini.fr

**CHERUBINI Deutschland GmbH**

Rotter Viehtrift 4A - 53842 Troisdorf - Deutschland  
Tel. +49 (0) 224 126 699 74 | Fax +49 (0) 224 126 699 73  
info@cherubini-group.de | www.cherubini-group.de